

# 2704

MODEL



## Advanced Process Controller/ Programmer Specification Sheet

- 3 Control loops
- SP Programmer
- Customisable user interface
- Maths and logic functions
- Open communications

The 2704 is a highly accurate and stable process controller available in a single, dual or triple loop format. Features include setpoint programming and comprehensive selection of maths and logic functions.

Its user interface incorporates a bright dot matrix display, providing extreme flexibility and ease of use. It is a highly configurable product offering many features previously found only in programmable logic controllers. This enables systems to be implemented integrating the process control and logic functions of a machine, therefore simplifying system complexity and reducing the total system costs.

Configuration is achievable either via the front panel or using Eurotherm's iTools configuration software.

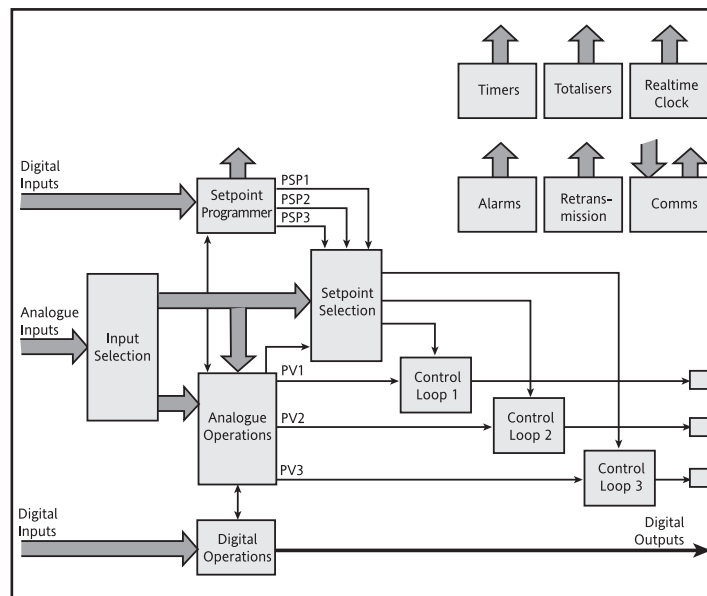

## Control functions

- 3 Control loops
- PID, VP or ON/OFF
- Cascade, ratio or override
- Gain scheduling
- Configurable control strategies

Eurotherm's advanced control algorithm gives stable straight-line control. Automatic tuning simplifies the commissioning procedure by performing a one shot tune to calculate the optimum PID values. To further optimise control especially in programmer applications, gain scheduling can be used to transfer control between up to six sets of PID values.

Trending enables the user to view, both current and historical information on the process variable and setpoint of each control loop.

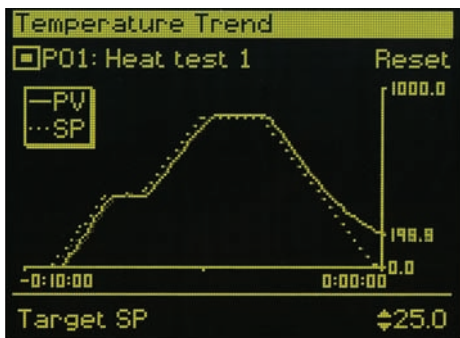

## IO Hardware

- 0.25uV PV input resolution
- Fixed and modular IO
- 250Vac isolation
- Expandable IO

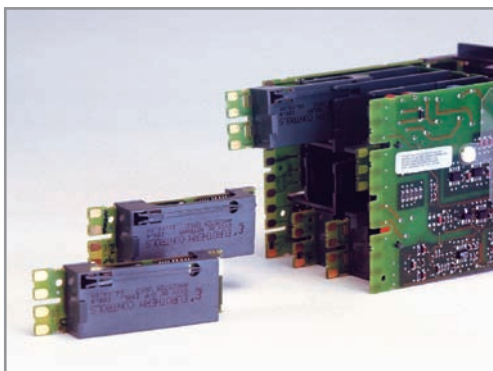

The 2704 incorporates a self correcting input circuit (INSTANT ACCURACY) to maximise accuracy and performance during initial warm up and changes in ambient temperature.

One universal and one high level analogue inputs, along with 10 digital IO are included as standard. Additionally, a further 5 IO modules may be fitted providing very flexible input/output combinations.

## Setpoint programmer

- 60 Programs
- 3 Profiled setpoints/program
- 600 Segments
- 16 Event outputs
- Program mimic display

Ideal for applications such as atmosphere or vacuum furnaces, and environmental chambers. The 2704 user interface offers the user an extremely easy method of editing, selecting and running programs.

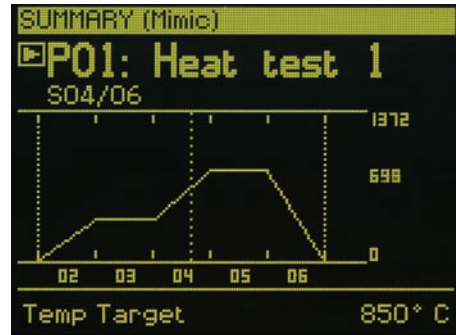

## iTools Setpoint program editor

- Offline or online editing on PC
- Graphical representation
- Advanced editing functions
- Storage and retrieval of program files

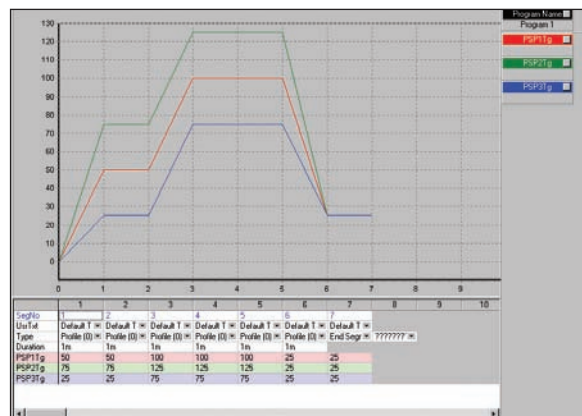

## Toolkit functions

- Mathematical calculations
- Combinational logic
- Real time clock
- Timer functions

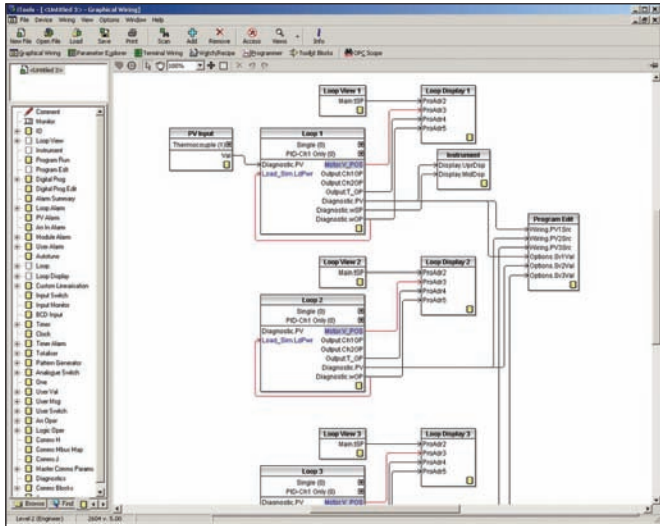

iTools Graphical Wiring Editor

Operators include;

Add, Subtract, Log, Exp, SQRT, AND, OR  
Max, Min, Select and many more

ToolKit blocks allows the user to create custom solutions by internally wiring analogue and digital operations together in flexible ways. 32 analogue and 32 digital operations are available. Other functions are available including timers, totalisers and a real time clock.

## Slave communications

- Modbus™ RTU protocol
- Ethernet Modbus/TCP protocol
- Profibus DP
- DeviceNet® communications
- El-Bisync

The 2704 supports two slave communication ports. Its modular build provides the user with a selection of communication protocols allowing easy integration into both PLC and PC supervisory systems.

When using Profibus DP a GSD file has to be created, containing the information relating to the instruments parameters, that a Profibus master needs in order to communicate with its slave device. The GSD file for a 2704 is created using Eurotherm's GSD file editor.

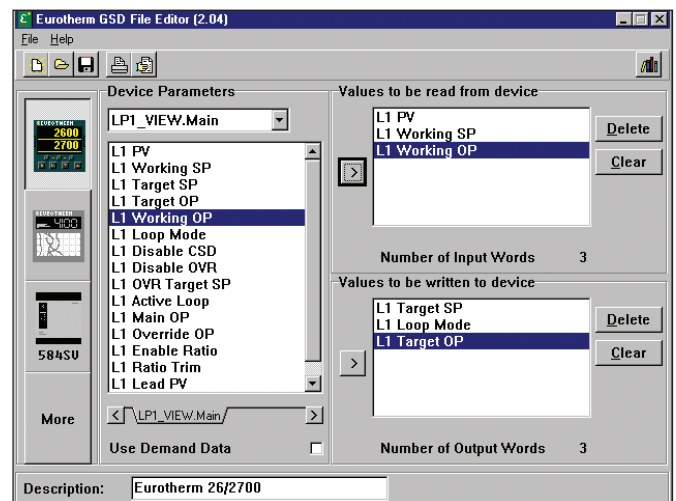

Profibus GSD editor

## Master communications

- Modbus protocol
- 100 read/write parameters
- Expands available hardware
- Interfaces to most Modbus slaves

Master modbus communications significantly increases the applications open to 2704. In its simplest form it can be used to retransmit a setpoint to a number of slave controllers in a multi-zone furnace. Alternatively, it can be integrated with an 8 loop blind controller to provide a remote operator interface with SP programmer functions.

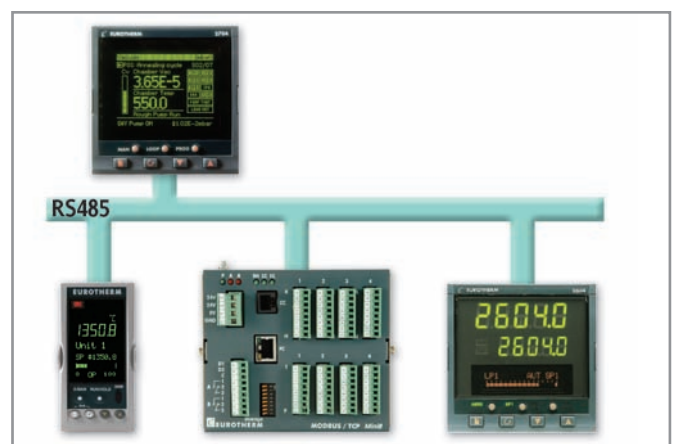

## Vacuum

- Direct interface to vacuum gauges
- Auto Hi/Lo gauge selection
- 6 Vacuum setpoints
- Pump timeout alarm
- Leak detection routine

At the heart of the vacuum controller is a specially designed function block capable of accepting up to three vacuum inputs. The 2704 is capable of being used solely to control the vacuum pump down sequence of a furnace, or as an integral furnace controller where both temperature and vacuum are controlled.

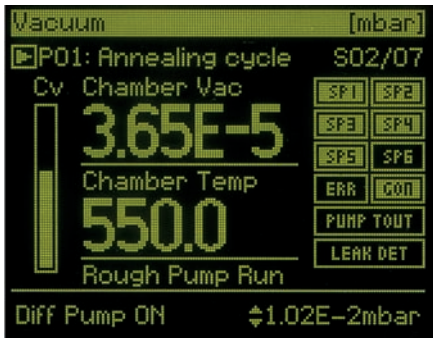

## Melt pressure

- 350Ω Strain gauge input
- Transducer excitation
- Pressure alarms
- Screen blockage alarm
- Simple user calibration with shunt

Suitable for precision pressure control in the plastic extrusion industries. Additionally a second pressure transducer can be used to provide a differential pressure alarm when the screen starts to block. Various machine start up strategies can be used to ensure a smooth transition from auto to manual mode.

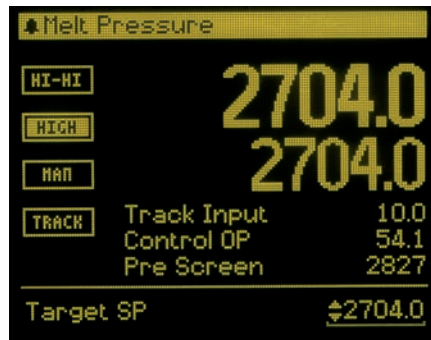

## Carbon potential

- %CP, O<sub>2</sub> or Dewpoint measurement
- CO correction
- Probe burn off and impedance monitoring
- Sooting alarm

Ideal for use in gas carburising furnaces where Zirconia probes are used to measure Carbon Potential. A three loop controller can be used to control furnace temperature, carbon potential and quench. The setpoint programmer is used in batch applications to generate synchronised temperature and carbon profiles.

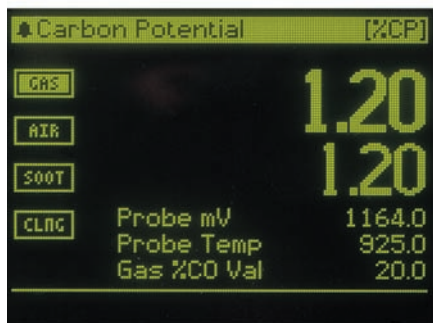

## Customisable display

By using flexible User Pages, the user has the option of defining how the process screens are viewed.

A maximum of eight user pages can be configured.

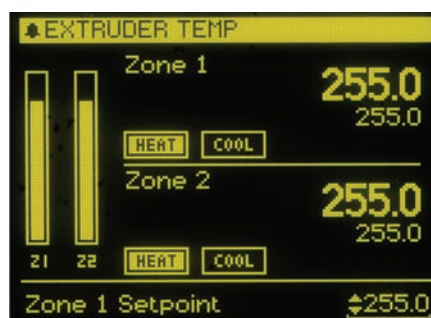
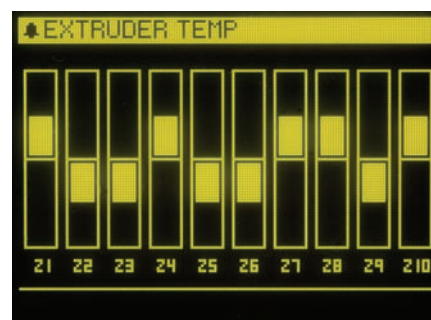
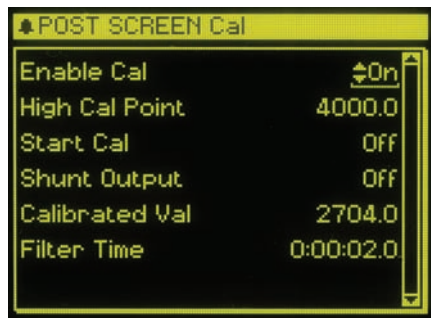

## SPECIFICATION

### General

#### Environmental performance

Temperature limits	Operation: 0 to 50°C Storage: -10 to 70°C
Humidity limits	Operation: 5 to 85% RH non condensing Storage: 5 to 85% RH non condensing
Panel sealing:	IP65, Nema 4X
Vibration:	2g peak, 10 to 150Hz
Altitude:	<2000 metres
Atmospheres:	Not suitable for use in explosive or corrosive atmosphere

#### Electromagnetic compatibility (EMC)

Emissions and immunity BS EN61326

Suitable for domestic, commercial and light industrial as well as heavy industrial. (Domestic/light (Class B) emissions. Industrial (Class A) environmental immunity emissions.

With Ethernet module fitted product only suitable for Class A emissions.

#### Electrical safety

BS EN61010 Installation cat. II; Pollution degree 2

#### INSTALLATION CATEGORY II

The rate impulse voltage for equipment on nominal 230V mains is 2500V.

#### POLLUTION DEGREE 2

Normally, only non-conductive pollution occurs. Occasionally, however, a temporary conductivity caused by condensation shall be expected

#### Physical

Panel mounting:	1/4 DIN
Dimensions and weight:	96W x 96H x 150D mm, 600g
Panel cut-out dimensions:	92W x 92Hmm

#### Control options

No. of loops:	1, 2 or 3 loops
Options:	Cascade, Ratio or Override
Modes:	PID, ON/OFF or Valve Position
Applications:	Carbon Potential, Humidity

#### Approvals

CE, cUL listed (file E57766), EAC  
Suitable for use in Nadcap and AMS2750D applications under System Accuracy Test calibration conditions

### Standard I/O

Precision PV input	
Accuracy:	±0.1%
Ranges:	mV, mA, volts or RTD (PT100)
Thermocouple types:	J, K, I, N, R, S, B, PII, C, plus others
Cold junction:	Ext 0°C, 45°C or 50°C

#### Analogue input

Allocation:	1 fitted
Accuracy:	± 0.1%
Ranges:	-10V to 10V or 0 to 20mA

#### Digital I/O

Types:	1 digital input 7 Bi-directional input/outputs 1 Changeover relay
--------	---

### Modules

#### Digital outputs

Types:	Single Relay, Dual Relay, Single Triac, Dual Triac, Single Logic and Triple Logic module
Allocation:	Slot 1, 3, 4, 5 or 6 (Max 3 Triacs per unit)

#### Digital inputs

Types:	Triple contact input, Triple logic input
Allocation:	Slot 1, 3, 4, 5 or 6

#### Analogue outputs

Types:	DC Control or DC retransmission (5 Max)
Allocation:	Slot 1, 3, 4, 5 or 6
Range:	0 to 20mA or 0 to 10V dc

#### Dual analogue output

Allocation:	Slot 1, 4 or 5
Range:	4-20mA or 24V dc transmitter PSU

#### High resolution analogue output

Allocation:	Slot 1, 4 or 5
Range:	4-20mA and 24V dc transmitter PSU

#### Transmitter PSU

Allocation:	Slot 1, 3, 4, 5 or 6
Transmitter:	24V dc @ 20mA

#### Transducer supply

Bridge voltage:	Software selectable, 5 or 10Vdc
Bridge resistance:	300Ω to 15Kohms

#### Potentiometer input

Potentiometer resistance:	330Ω to 150kohms
---------------------------	------------------

#### Precision PV input (module)

Allocation:	Slot 3 or 6
Accuracy:	±0.1%
Ranges:	mV, mA, volts or RTD (PT100)
Thermocouple types:	J, K, T, L, N, R, S, B, PII, C, plus others
Cold junction:	Ext 0°C, 45°C or 50°C

#### 4 wire PRT (modules)

Allocation:	Slot 3 or 6
Accuracy:	<0.005%
Types:	PRT 100, PRT 25.5
Range:	-200 to +850°C

#### Dual (probe) input

Allocation:	Slot 3 or 6
Accuracy:	±0.1%
Ranges:	mV, mA, volts or RTD (PT100)
Thermocouple types:	J, K, T, L, N, R, S, B, PII, C, plus others
Cold junction:	Ext 0°C, 45°C or 50°C

#### TDS (module)

Allocation:	Slot 1, 3, 4, 5 or 6
Accuracy:	1% of reading down to 0.5% of range
Conductivity range:	40 to 500 000 uS
Measurement frequency:	1kHz
Max. cable length:	100m

#### Analogue input (module)

Allocation:	Slot 1, 3, 4 or 6
Accuracy:	±0.2%
Ranges:	mV, mA, volts or RTD (PT100)
Thermocouple types:	J, K, T, L, N, R, S, B, PII, C, plus others
Cold junction:	Ext 0°C, 45°C or 50°C

### Setpoint Programmer

No profiles:	1, 2 or 3 profiles
No. of programs:	60 programs max.
No. of segments:	600 time to target segments (max.) or 480 ramp rate segments (max.)
Event outputs:	Up to 16

### Advanced Functions

Application blocks:	32 digital operations 32 analogue operations 50 user values
Timers:	4 ON pulse, OFF delay, one shot and min-ON
Totalisers:	4, trigger level and reset input
Pattern generators:	16 patterns each with 16 bits
Real time clock:	Day of the week and time
Customisable screens:	8 user screens
User switches:	8, toggle and momentary function
<b>Slave communications</b>	
Allocation:	Slot H or J (Ethernet/DeviceNet®/Profibus slot H only)
Types:	Ethernet Modbus/TCP Profibus DP RS485 Modbus RTU RS485 (2 wire) RS485 (5 wire) or RS232 DeviceNet EI-Bisyc (subset of parameters)
<b>Master communications</b>	
Allocation:	Slot J
Types:	Modbus RTU RS485 (2 wire), RS485 (4 wire) or RS232
Parameters:	100 read/write

### Mechanical Details

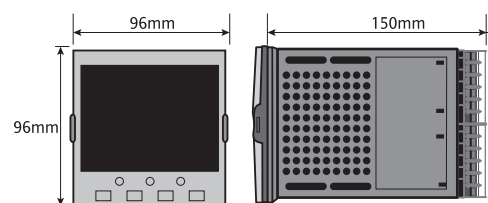

Panel cut-out 92mm (-0.0 +0.8) x 92mm (-0.0 +0.8)

## Ordering Code

### Hardware coding

	1	2	3	4	5	6	7	8	9	10	11	12	13
14													

#### Basic Product

2604	Standard
2604f	Profibus
2704	Standard
2704f	Profibus

#### 1 Supply Voltage

VH	85-264V ac
VL	20-29V ac or dc

#### 2 Loop/Programs

<b>First digit</b>	
1 - -	One loop
2 - -	Two loops
3 - -	Three loops
<b>Second digit</b>	
- X X	No programs
- 2 -	Twenty programs
- 5 -	Fifty programs
- A -	Asynchronous (Note 7)
<b>Third digit</b>	
- X X	No programs
-- 1	1 Profile
-- 2	2 Profile
-- 3	3 Profile

#### 3 Application

XX	Standard
ZC	Zirconia
V1	1 Gauge V ac. (Note 7)
V3	3 Gauge V ac. (Note 7)
BC	Boiler (Note 7)

#### 4-8 IO Slots 1, 3, 4, 5, 6

XX	None fitted
R4	Change over relay
R2	2 Pin relay
RR	Dual relay
T2	Triac
TT	Dual triac
D4	DC Control
D6	DC retransmission
PV	PV Input (Slots 3 & 6 only)
TL	Triple logic input
TK	Triple contact input
TP	Triple logic output
MS	24Vdc transmitter PSU
VU	Pot. input
G3	5Vdc transducer PSU
G5	10Vdc transducer PSU
AM	Analogue input module (not in slot 5)
DP	Dual DC (probe) input (Note 4) (Slots 3 and 6 only)
DO	Dual 4-20mA OP/24Vdc PSU (Slots 1, 4 & 5 only)
LO	Isolated single logic OP
HR	Hi Resolution DC retrans and 24Vdc PSU (Slots 1, 4 and 5 only)
TD	TDS input (Note 7)
PH	4W PRT input (100R) (Note 7) (Slots 3 and 6 only)
PL	4W PRT input (25.5R) (Note 7) (Slots 3 and 6 only)

#### 9 H Comms Slot

XX	Not fitted
A2	EIA232 Modbus
Y2	2-wire EIA485 Modbus
F2	4-wire EIA485 Modbus
AE	EIA232 EI-Bisynch (Note 5)
YE	2-wire EIA485 EI-Bisynch (Note 5)
FE	4-wire EIA485 EI-Bisynch (Note 5)
ET	Ethernet Modbus TCP (incl RJ45 Assy) (Note 7)
PB	Profibus DP
DN	DeviceNet

#### 10 J Comms Slot

XX	Not fitted
A2	EIA232 Modbus
Y2	2-wire EIA485 Modbus
F2	4-wire EIA485 Modbus
M1	232 Master
M2	2W 485 Master
M3	4W 485 Master

#### 11 Manual Language

ENG	English
FRA	French
GER	German
SPA	Spain
ITA	Italian
NED	Dutch
SWE	Swedish

#### 12 Toolkit Functions

XX	Standard
U1	Toolkit level 1 (Note 2)
U2	Toolkit level 2 (Note 3)

#### 13 Technical Support

TS1	1 Hour
TS2	2 Hours
TS4	4 Hours
TS8	8 Hours

#### 14 Configuration Tools

XX	None
IT	iTools

#### Notes

1. Basic Controller/Programmer includes 8 digital registers, 4 timers and 4 totalisers.
2. Toolkit 1 includes 16 analogue, 16 digital, pattern generator, digital programmer, analogue switch and 4 user values.
3. Toolkit 2 includes Toolkit 1 plus extra 8 analogue, 16 digital\operations and 8 user values.
4. Dual analogue input suitable for Carbon Probes. (Inputs not isolated from each other)
5. EI-Bisync includes only a subset of parameters.
6. The HR module has 1 high resolution DC output and 1 24Vdc power supply.
7. Only available on 2704

# Configuration coding (optional)

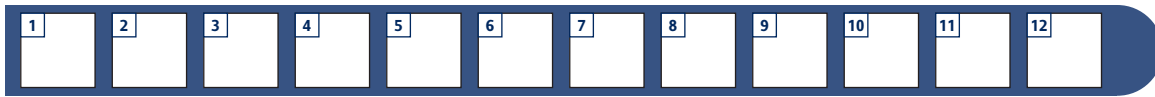

1 Loop Function	
XXXX	None
S_ _ _	Standard PID
C_ _ _	Cascade
R_ _ _	Ratio
O_ _ _	Override(7)
_PID	PID control
_ONF	On/Off control
_PIF	PID/OnOff control
_VP1	VP without feedback
_VP2	VP with feedback

4-6 Process Inputs (Input Type)	
X	None
J	J Thermocouple
K	K Thermocouple
T	T Thermocouple
L	L Thermocouple
N	N Thermocouple
R	R Thermocouple
S	S Thermocouple
B	B Thermocouple
P	Platinell II
C	C Thermocouple
Z	RTD/Pt100
A	4-20mA linear
Y	0-20mA linear
W	0-5Vdc linear
G	1-5Vdc linear
V	0-10Vdc linear
Custom downloads (replace C)	
D	Custom curve
E	D thermocouple
1	Ni/Ni18%Mo
2	Pt20%Rh/Pt40%Rh
3	W/W26%Re (Engelhard)
4	W/W26%Re (Hoskins)
5	W5%Re/W26%Re (Engelhard)
6	W5%Re/W26%Re (Bucose)
7	Pt10%Rh/Pt40%Rh
8	Exergen K80 I.R. pyrometer

7 Analogue Input	
XXX	None
P2-	PV Loop 2
P3-	PV Loop 3
S1-	SP Loop 1
S2-	SP Loop 2
S3-	SP Loop 3
A1-	Aux. PV Loop 1
A2-	Aux. PV Loop 2
A3-	Aux. PV Loop 3
L1-	Ratio Lead PV Loop 1
L2-	Ratio Lead PV Loop 2
L3-	Ratio Lead PV Loop 3

For range select third digit from Table 1

8-12 Slot Functions 1, 3, 4, 5, 6	
XXX	Unconfigured
1 - -	Loop 1
2 - -	Loop 2
3 - -	Loop 3
Single Relay, Triac, Logic	
-HX	Heat
-CX	Cool
Dual Relay or Triac	
-HC	PID Heat & Cool
-VH	VP Heat
-AA	FSH & FSH
-AB	FSH & FSL
-AC	DH & DL
-AD	FSH & DH
-AE	FSL & DL
-AF	FSL & FSL
-AG	FSH & DB
-AH	FSL & DB
-AJ	DB & DB
HHX	Heat output for loops 1 & 2
CCX	Cool output for loops 1 & 2
P12	Prog events 1 & 2
P34	Prog events 3 & 4
P56	Prog events 5 & 6
P78	Prog events 7 & 8
Triple Logic Output	
-HX	CH1 Heat
-CX	CH1 Cool
-HC	CH1 Heat, CH2 Cool
HHX	Heat output for loops 1 & 2
HHH	Heat output for loops 1, 2 & 3

Single DC Outputs	
For range select third digit from Table 1	
-H-	PID Heat
-C-	PID Cool
-T-	PV retransmission
-S-	SP retransmission
Precision PV Input	
-PV	PV input module
-PA	Aux PV input (Note 8)
-PL	Ratio lead input
Analogue Input	
For range select third digit from Table 1	
-R-	Setpoint
Auxiliary & Lead PV Inputs	
For range select third digit from Table 1	
-L-	Ratio lead input
-B-	Aux. PV input
Potentiometer Input	
-VF	VP Heat feedback
-RS	Remote SP
Dual DC 4-20mA/24Vdc PSU Output	
HHX	Heat output for loops 1 & 2
-HC	Heat Cool
-HT	CH1 Heat, Ch 2 PSU
TTX	Both channels PSU
High Resolution DC OP	
-TA	4-20mA PV Retrains
-TV	0-10V PV Retrains
-SA	4-20mA SP Retrains
-SV	0-10V SP Retrains

Table 1	
A	4-20mA Linear
Y	0-20mA Linear
W	0-5V dc Linear
G	1-5V dc Linear
V	0-10V dc Linear

### Notes

- Loop 1 PV defaults to main PV input on microboard. Loop 2 and 3 PV inputs must be fitted in I/O slots 3 or 6 or be assigned to the analogue input.
- Alarm configuration refers to loop alarms only. One selection is allowed per loop. Additional alarms are available for the user to configure.
- Thermocouple and RTD inputs assume sensor min and max values with no decimal point.
- Linear inputs are ranged 0-100%, no decimal point.
- Temperature units will be °C unless ordered by USA where °F will be used.
- Remote setpoints assume loop min & max ranges.
- VP1, VP2, VP3 and VP4 are not available with override function.
- For Cascade and Override inputs only.
- HR module should be used in feedback mode, please refer to TIBC160.

## Rear terminal connections

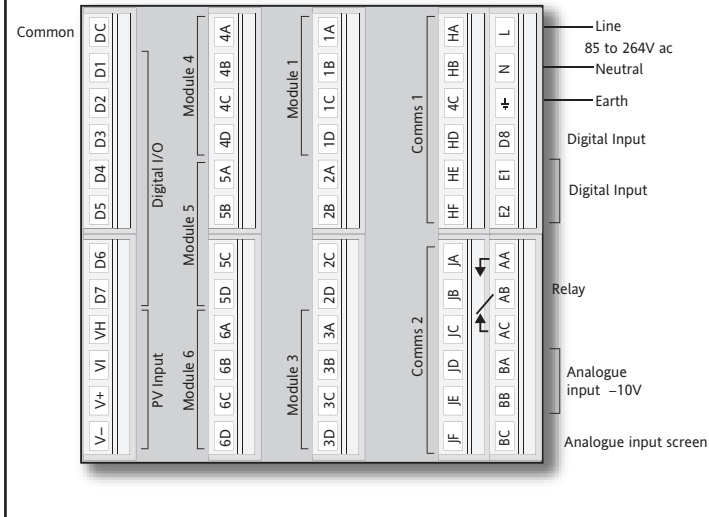

## Isolation

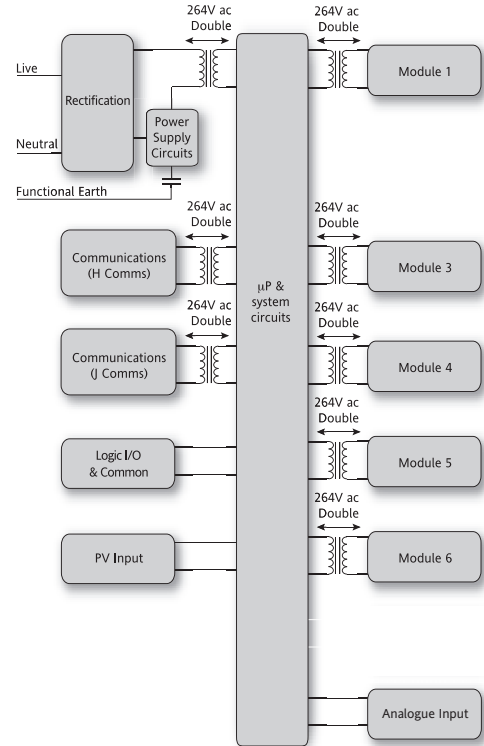

## Eurotherm: International sales and service

Understanding and providing local support is a key part of Eurotherm business. Complementing worldwide Eurotherm offices are a whole range of partners and a comprehensive technical support team, to ensure you get a service you will want to go back to.

**AUSTRALIA** Sydney  
Eurotherm Pty. Ltd.  
T (+61 2) 9838 0099  
F (+61 2) 9838 9288  
E [info.au@eurotherm.com](mailto:info.au@eurotherm.com)

**AUSTRIA** Vienna  
Eurotherm GmbH  
T (+43 1) 7987601  
F (+43 1) 7987605  
E [info.at@eurotherm.com](mailto:info.at@eurotherm.com)

**BELGIUM & LUXEMBOURG** Moha  
Eurotherm S.A./N.V.  
T (+32) 85 274080  
F (+32) 85 274081  
E [info.be@eurotherm.com](mailto:info.be@eurotherm.com)

**BRAZIL** Campinas-SP  
Eurotherm Ltda.  
T (+5519) 3707 5333  
F (+5519) 3707 5345  
E [info.br@eurotherm.com](mailto:info.br@eurotherm.com)

**CHINA**  
Eurotherm China  
T (+86 21) 61451188  
F (+86 21) 61452602  
E [info.cn@eurotherm.com](mailto:info.cn@eurotherm.com)

**Beijing Office**  
T (+86 10) 63108914  
F (+86 10) 63107291  
E [info.cn@eurotherm.com](mailto:info.cn@eurotherm.com)  
**Guangzhou Office**  
T (+86 20) 38106506  
F (+86 20) 38106511  
E [info.cn@eurotherm.com](mailto:info.cn@eurotherm.com)

**DENMARK** Copenhagen  
Eurotherm Danmark AS  
T (+45 70) 234670  
F (+45 70) 234660  
E [info.dk@eurotherm.com](mailto:info.dk@eurotherm.com)

**FINLAND** Abo  
Eurotherm Finland  
T (+358) 22506030  
F (+358) 22503201  
E [info.fi@eurotherm.com](mailto:info.fi@eurotherm.com)

**FRANCE** Lyon  
Eurotherm Automation SA  
T (+33 478) 664500  
F (+33 478) 352490  
E [info.fr@eurotherm.com](mailto:info.fr@eurotherm.com)

**GERMANY** Limburg  
Eurotherm Deutschland GmbH  
T (+49 6431) 2980  
F (+49 6431) 298119  
E [info.de@eurotherm.com](mailto:info.de@eurotherm.com)

**HONG KONG**  
Eurotherm Hongkong  
T (+85 2) 28733826  
F (+85 2) 28700148  
E [info.hk@eurotherm.com](mailto:info.hk@eurotherm.com)

**INDIA** Chennai  
Eurotherm India Limited  
T (+91 44) 24961129  
F (+91 44) 24961831  
E [info.in@eurotherm.com](mailto:info.in@eurotherm.com)

**IRELAND** Dublin  
Eurotherm Ireland Limited  
T (+353 1) 4691800  
F (+353 1) 4691300  
E [info.ie@eurotherm.com](mailto:info.ie@eurotherm.com)

**ITALY** Como  
Eurotherm S.r.l.  
T (+39 031) 975111  
F (+39 031) 977512  
E [info.it@eurotherm.com](mailto:info.it@eurotherm.com)

**KOREA** Seoul  
Eurotherm Korea Limited  
T (+82 31) 2738507  
F (+82 31) 2738508  
E [info.kr@eurotherm.com](mailto:info.kr@eurotherm.com)

**NETHERLANDS** Alphen a/d Rijn  
Eurotherm B.V.  
T (+31 172) 411752  
F (+31 172) 417260  
E [info.nl@eurotherm.com](mailto:info.nl@eurotherm.com)

**NORWAY** Oslo  
Eurotherm A/S  
T (+47 67) 592170  
F (+47 67) 118301  
E [info.no@eurotherm.com](mailto:info.no@eurotherm.com)

**POLAND** Katowice  
Invensys Eurotherm Sp z o.o.  
T (+48 32) 2185100  
F (+48 32) 2185108  
E [info.pl@eurotherm.com](mailto:info.pl@eurotherm.com)

**SPAIN** Madrid  
Eurotherm España SA  
T (+34 91) 6616001  
F (+34 91) 6619093  
E [info.es@eurotherm.com](mailto:info.es@eurotherm.com)

**SWEDEN** Malmo  
Eurotherm AB  
T (+46 40) 384500  
F (+46 40) 384545  
E [info.se@eurotherm.com](mailto:info.se@eurotherm.com)

**SWITZERLAND** Wallerau  
Eurotherm Produkte (Schweiz) AG  
T (+41 44) 7871040  
F (+41 44) 7871044  
E [info.ch@eurotherm.com](mailto:info.ch@eurotherm.com)

**UNITED KINGDOM** Worthing  
Eurotherm Limited  
T (+44 1903) 268500  
F (+44 1903) 265982  
E [info.uk@eurotherm.com](mailto:info.uk@eurotherm.com)  
[www.eurotherm.co.uk](http://www.eurotherm.co.uk)

**U.S.A.** Leesburg VA  
Eurotherm Inc.  
T (+1 703) 443 0000  
F (+1 703) 669 1300  
E [info.us@eurotherm.com](mailto:info.us@eurotherm.com)  
[www.eurotherm.com](http://www.eurotherm.com)

ED57

©Eurotherm Limited 2022

Invensys, Eurotherm, the Eurotherm logo, Chessell, EurothermSuite, Mini8, Eyon, Eyriss, EPower and Wonderware are trademarks of Invensys plc, its subsidiaries and affiliates. All other brands may be trademarks of their respective owners.

All rights are strictly reserved. No part of this document may be reproduced, modified, or transmitted in any form by any means, nor may it be stored in a retrieval system other than for the purpose to act as an aid in operating the equipment to which the document relates, without the prior written permission of Eurotherm limited.

Eurotherm Limited pursues a policy of continuous development and product improvement. The specifications in this document may therefore be changed without notice. The information in this document is given in good faith, but is intended for guidance only.

Eurotherm Limited will accept no responsibility for any losses arising from errors in this document.

Part No. HA026916 Issue 10  
\*(Part No. HA026916 Issue 8 2008)

2704 Specification Sheet



Printed on recycled paper