

Radiant Heaters

The RAYMAX® Family

Watlow's diverse RAYMAX® heater line allows you to solve virtually any application that requires radiant heat. Our capabilities cover a wide range of needs, from contamination-resistant surfaces, to fast responding high temperature panels, to replaceable tubular elements.

Applying radiant heaters can be complicated. Watlow's engineering staff has the level of training and expertise required to help meet your application requirements, providing a high degree of technical support such as conducting testing for your application at our facility, calculating your watt density and temperature requirements, and recommending system components such as sensors and controllers. With our experience in a wide range of industries, chances are Watlow has already helped someone handle a radiant heating application like yours.

Features and Benefits

Variety of styles

- Matches the ideal temperature and watt density requirements of your application

Watlow engineering and application support

- Helps projects run smoothly

Custom designs

- Can be quickly adapted for particular needs such as special wattage zoning

Watlow sensors and controllers are completely compatible with RAYMAX heaters

- Offers a single source thermal system that is reliable and designed just for your application



Applications

- Thermoforming
- Food warming
- Paint and epoxy curing
- Heat treating
- High temperature furnaces
- Tempering and annealing processes



Caution: Fire Hazard

Radiant heaters must not be operated in the presence of flammable vapors, gases or combustible materials without proper ventilation and safety precautions. Radiant heaters must be properly wired and controlled to comply with all applicable electrical codes.

Radiant Heaters

The RAYMAX Family

Panel Variations

Low Profile

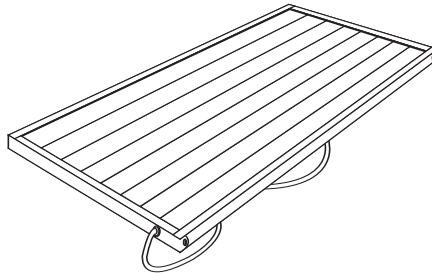

This design may be required where mounting space is limited, for example, when converting existing equipment or designs to radiant panels.

Available options may vary from the standard units when you specify a low profile design. Consult Watlow for further information.

Available with RAYMAX 1010, 1120, 1220 and 2030.

Zoning

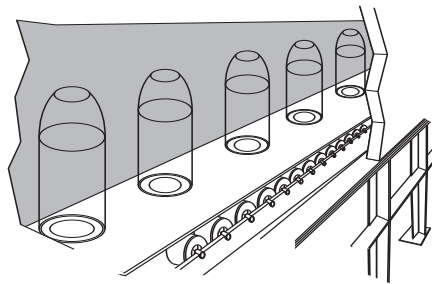

Watt densities can be varied across the entire width of RAYMAX heaters. If desired, each zone can have an individually controlled power supply.

Zoning can be very valuable when part of the product requires more heat, or when you must compensate for heat losses at the edges. By separately turning off part of the heated width, you can adjust for various widths of material.

Available with RAYMAX 1010, 1120, 1220, 1330, and 2030.

Radiant Heaters

The RAYMAX Family Mounting Accessories

Application note: Allow for some thermal expansion of the heater case during operation. An expansion of up to one percent can occur when the case reaches its normal maximum limit of 1100°F (595°C). If your equipment has mounting screws to connect to the slots in the mounting legs, allow for a small amount of extra length. If you are using mounting holes to interface with the mounting studs on the back of the RAYMAX case, make sure your holes are oversized. Also, use washers and avoid overtightening.

Mounting Studs

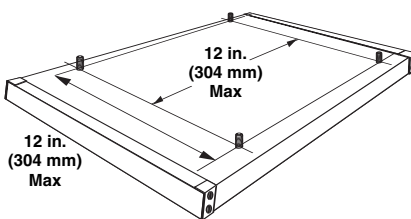

Standard ¼-20 X 1 ½ inch (M6-1 X 40) steel studs are welded to the case. For best support, studs should be approximately located on 12 inch centers. Consult Watlow for exact locations on specific heaters.

Available with RAYMAX 1010, 1120, 1220, 1330, and 2030.

Mounting Legs

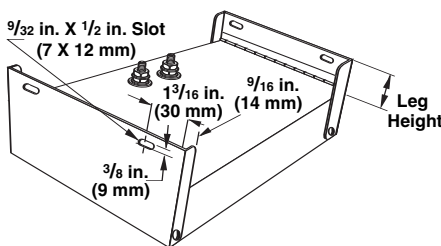

Mounting legs are extensions of the steel end caps with mounting slots for bolting directly to field support members. There is no extra charge for legs; they can be supplied in half inch increment from 0.5 inch (12.5 mm) to three inches (76 mm). No slots are provided in legs less than one inch (25 mm) long.

For panels over 24 inches (610 mm) long, mounting studs are recommended for the best panel support.

Available with RAYMAX 1120, 1220, and 2030.

Terminal Accessories

Special Terminal Locations

If the standard terminal locations shown will not meet your needs special locations can be designed.

Available with RAYMAX 1010, 1120, 1220, 1330, and 2030.

Terminal Box

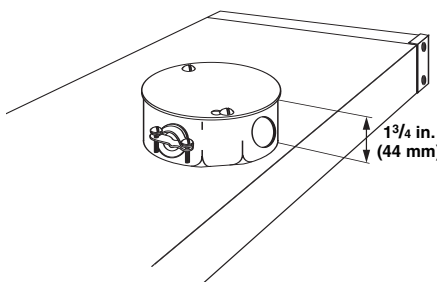

To protect electrical connections, a standard NEMA octagon terminal box is available. The standard size is 3 5/16 X 3 5/16 X 1 ½ inches (90.5 X 90.5 X 38.1 mm) with knockouts for ½ inch (12.5 mm) conduit. Other NEMA sizes are also available.

Care should be taken to use lead wire capable of withstanding the ambient temperatures.

Available with RAYMAX 1010, 1120, 1220, 1330, and 2030.

Wiring Raceway

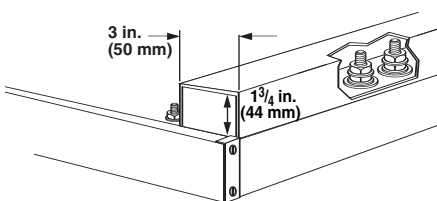

Custom designed to your specific requirements, a steel raceway provides electrical and physical protection for all terminal connections. This can be particularly useful for multi-zone panels.

Available with RAYMAX 1010, 1120, 1220, 1330, and 2030.

Radiant Heaters

The RAYMAX Family Temperature Control

Thermowells

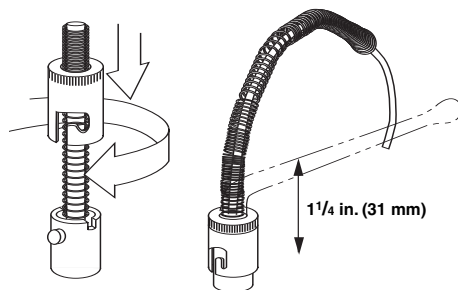

A thermowell allows you to use a thermocouple with a bayonet fitting to monitor heater temperature. The thermowell is located on the back of the panel to allow easy access for thermocouple replacement. Spring tension holds the tip of the thermocouple in contact for close control of the heater temperature. Thermocouple not included.

Available with RAYMAX 1010, 1120, and 1330.

Thermocouple Clamps

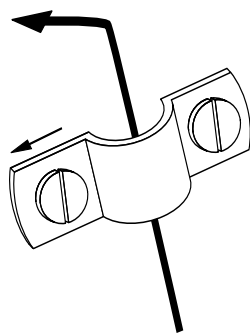

A thermocouple mounting clamp can be provided on the end of the heater case. The clamp is suitable for use with 1/8 inch (3.175 mm) and 1/4 inch (6.35 mm) O.D. sheath thermocouples, which should be bent 90° so that the sensing tip is just above and lightly touching the hot face at an element location.

Available with RAYMAX 1220, 1525 (1/8 only), 1626 (1/8 only) and 2030.

Welded Thermocouple

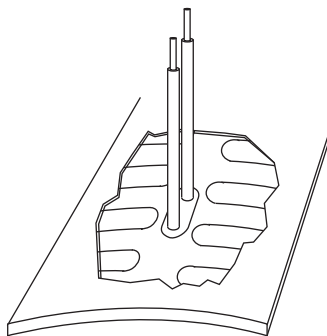

A thermocouple junction is welded to the emitting surface to provide optimum temperature sensing accuracy and responsiveness. This option permits the actual radiating face temperature to be precisely monitored and controlled. The standard length of the thermocouple wire is 12 inches (304.8 mm).

Available with RAYMAX 1010, 1120, and 1330.

Thermocouple Pocket

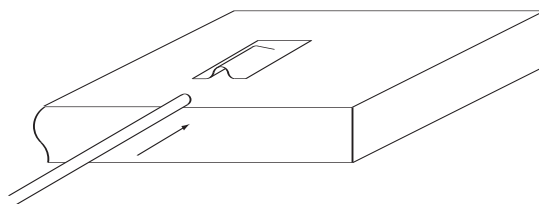

A thermocouple pocket is welded to the emitting surface. The pocket accepts a 0.063 inch (1.6 mm) diameter thermocouple (not included). This option provides accurate temperature sensing and easy thermocouple replacement.

Available with RAYMAX 1010, 1120, and 1330.

Radiant Heaters

RAYMAX® 1525

Watlow's RAYMAX® 1525 is a rugged radiant heater with a unique design that allows quick removal and replacement of the element and reflectors. Instead of dismantling the heater, the parts are simply removed from the front. Replacing dirty reflectors often can improve heating efficiency by up to 30 percent.

The RAYMAX 1525 is available with either a fast responding quartz element or an Incoloy®-sheathed WATROD tubular element. Both are supported by stainless steel hardware in an extruded aluminum housing.

All stock units come with 1½ inch long, ⅜ inch-16 thread mounting bolts that slide along the heater's length to accommodate mounting considerations.

Performance Capabilities

- Element temperatures to 1600°F (870°C)
- Watt densities measured across the reflector area up to 25 W/in² (3.9 W/cm²)

Features and Benefits

- **Fast and easy replacement** of the tubular element and reflectors for quick servicing.
- **Variety of element styles:** single or dual element, hairpin, liquid tight housing and quartz element.
- **Assembly stock availability** provides quick three-day shipment from order receipt.
- **Optional single end wiring**, available on most units, simplifies installation.
- **Polished aluminum reflector** efficiently directs heat to the work.

Applications

- Drying bulk materials
- Freeze protection
- Space heating
- Process heating
- Warming equipment

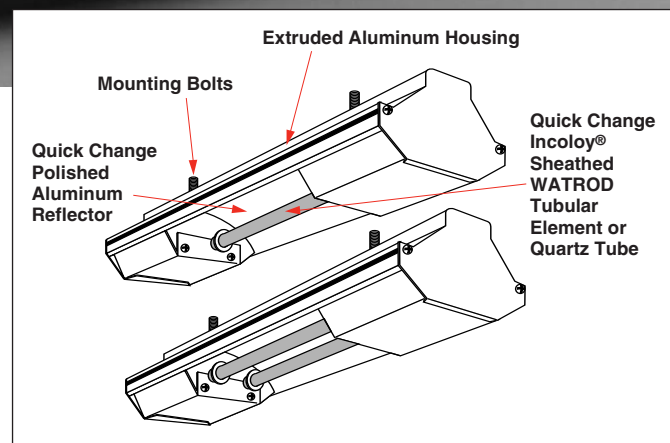
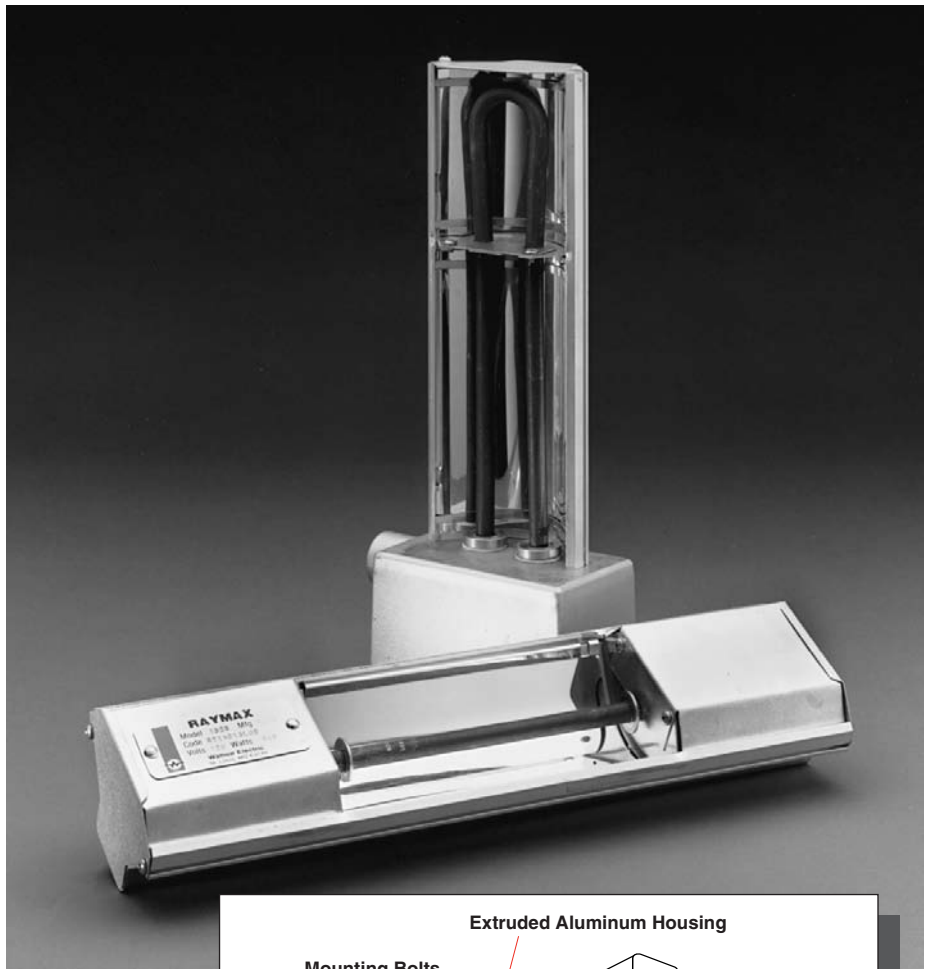

Options

Single End Wiring

Single end wiring permits power leads to be brought into only one end of the unit. Standard units with straight elements must be wired at both ends.

Power Leads

Appropriate power leads come attached to the heating element(s). To order, simply specify **length** and **flexible conduit**, if required.

Protective Grille

A stainless steel grille section that snaps in to reduce the possibility of personnel or product coming in contact with the heating elements.

Incoloy® is a registered trademark of Special Metals Incorporated.

Radiant Heaters

RAYMAX 1525

Options

Continued

Element Styles

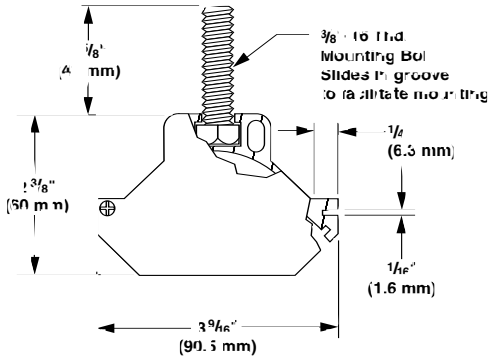

Protective Grille

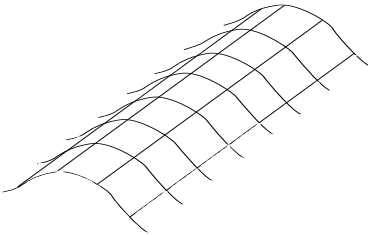

Single and Dual Elements

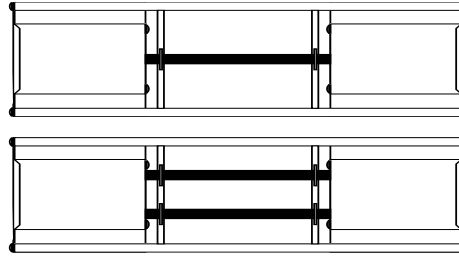

Straight length WATROD tubular elements come in single or dual styles. The dual style produces twice the wattage of the same length single element. Dual elements can also be jumpered to permit single end wiring and operating at twice the rated voltage up to 480V~(ac).

Hairpin Element

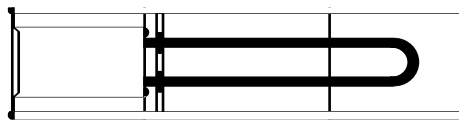

A WATROD hairpin-shaped tubular element provides the convenience of single end wiring and a reduced no-heat area on the non-terminal end.

Liquid Tight Housing

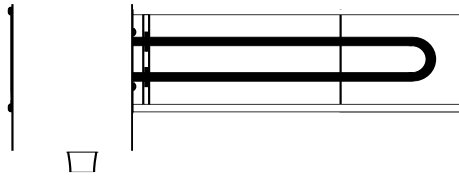

On this style, the hairpin element terminates in a liquid tight housing to permit operation in a hose-down area or exposure to weather. The cast aluminum housing has a 1/2 inch NPT conduit fitting. The box is 2 13/16 inches x 3 3/8 inches x 5 1/4 inches including conduit hub.

Quartz Tube Element

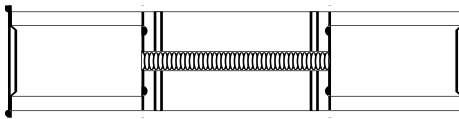

Watlow quartz elements provide the advantage of faster heat-up and cool-down—important when encountering frequent line stoppages. A standard 1/2 inch (13 mm) diameter quartz tube provides strength and long resistance wire life.

F.O.B.: St. Louis, Missouri

How to Order

To order, specify:

- Watlow code number
- Watts/volts
- Options
- Quantity

If our stock units do not meet your application needs, Watlow can manufacture to meet your special requirements. For **made-to-order** units, please specify:

- Overall or heated length
- Element style
- Volts/watts
- Options
- Quantity

Availability

Assembly Stock: Three working days

Made-to-Order: Consult Watlow

Radiant Heaters

F.O.B.: St. Louis, Missouri

Radiant Heaters

RAYMAX 1525

Single Element



| Overall Length in (mm) | Heated Length in (mm) | Volts | kW | Approx Net Wt. lbs (kg) | Availability | Code No. | Replacement Element Code No. | Replacement Reflector Code No. |
|---------------------------|--------------------------|-------|------|----------------------------|--------------|------------|------------------------------|--------------------------------|
| 13 5/8 (345) | 7 1/4 (185) | 120 | 0.40 | 1.9 (0.88) | Assy. Stock | RT1A013L00 | RDN10E1 | RR1013L00 |
| 20 5/8 (510) | 13 5/8 (345) | 120 | 0.65 | 2.7 (1.3) | Assy. Stock | RT1A020A00 | RDN16L1 | RR1020A00 |
| 24 5/8 (620) | 16 13/16 (425) | 120 | 0.80 | 3.2 (1.5) | Assy. Stock | RT1A024G00 | RDN21B1 | RR1024G00 |
| 24 5/8 (620) | 16 13/16 (425) | 240 | 0.80 | 3.2 (1.5) | Assy. Stock | RT1G024G00 | RDN21B10 | RR1024G00 |
| 30 5/8 (780) | 22 5/8 (580) | 120 | 1.10 | 4.0 (1.8) | Assy. Stock | RT1A030L00 | RDN27C1 | RR1030L00 |
| 30 5/8 (780) | 22 5/8 (580) | 240 | 1.10 | 4.0 (1.8) | Assy. Stock | RT1G030L00 | RDN27C10 | RR1030L00 |
| 35 5/8 (910) | 27 5/8 (710) | 240 | 1.30 | 4.7 (2.2) | Assy. Stock | RT1G035R00 | RDN32C10 | RR1035R00 |
| 35 5/8 (910) | 27 5/8 (710) | 480 | 1.30 | 4.7 (2.2) | Assy. Stock | RT1P035R00 | RDN32C11 | RR1035R00 |
| 46 5/8 (1185) | 38 5/8 (980) | 240 | 1.80 | 5.8 (2.7) | Assy. Stock | RT1G046L00 | RDN42R10 | RR1046L00 |
| 46 5/8 (1185) | 38 5/8 (980) | 480 | 1.80 | 5.8 (2.7) | Assy. Stock | RT1P046L00 | RDN42R11 | RR1046L00 |
| 61 5/8 (1560) | 53 1/4 (1350) | 240 | 2.50 | 7.5 (3.4) | Assy. Stock | RT1G061G00 | RDN57J10 | RR1061G00 |
| 61 5/8 (1560) | 53 1/4 (1350) | 480 | 2.50 | 7.5 (3.4) | Assy. Stock | RT1P061G00 | RDN57J11 | RR1061G00 |
| 73 3/4 (1875) | 65 5/8 (1650) | 240 | 3.00 | 9.0 (4.1) | Assy. Stock | RT1G073N00 | RDN69E10 | RR1073N00 |
| 73 3/4 (1875) | 65 5/8 (1650) | 480 | 3.00 | 9.0 (4.1) | Assy. Stock | RT1P073N00 | RDN69E11 | RR1073N00 |
| 85 5/8 (2180) | 77 5/8 (1955) | 240 | 3.60 | 10.2 (4.7) | Assy. Stock | RT1G085N00 | RDN81E10 | RR1085N00 |
| 85 5/8 (2180) | 77 5/8 (1955) | 480 | 3.60 | 10.2 (4.7) | Assy. Stock | RT1P085N00 | RDN81E11 | RR1085N00 |

Dual Element

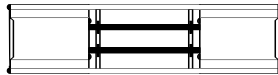

| | | | | | | | | |
|---------------|----------------|-----|------|------------|-------------|------------|----------|-----------|
| 13 5/8 (345) | 7 1/4 (185) | 120 | 0.80 | 2.2 (1.0) | Assy. Stock | RT2A013L00 | RDN10E1 | RR2013L00 |
| 20 5/8 (510) | 13 5/8 (345) | 120 | 1.30 | 2.9 (1.3) | Assy. Stock | RT2A020A00 | RDN16L1 | RR2020A00 |
| 24 5/8 (620) | 16 13/16 (425) | 120 | 1.60 | 3.4 (1.5) | Assy. Stock | RT2A024G00 | RDN21B1 | RR2024G00 |
| 24 5/8 (620) | 16 13/16 (425) | 240 | 1.60 | 3.4 (1.5) | Assy. Stock | RT2G024G00 | RDN21B10 | RR2024G00 |
| 30 5/8 (780) | 22 5/8 (580) | 120 | 2.20 | 4.1 (1.9) | Assy. Stock | RT2A030L00 | RDN27C1 | RR2030L00 |
| 30 5/8 (780) | 22 5/8 (580) | 240 | 2.20 | 4.1 (1.9) | Assy. Stock | RT2G030L00 | RDN27C10 | RR2030L00 |
| 35 5/8 (910) | 27 5/8 (710) | 240 | 2.60 | 4.7 (2.1) | Assy. Stock | RT2G035R00 | RDN32C10 | RR2035R00 |
| 35 5/8 (910) | 27 5/8 (710) | 480 | 2.60 | 4.7 (2.1) | Assy. Stock | RT2P035R00 | RDN32C11 | RR2035R00 |
| 46 5/8 (1185) | 38 5/8 (980) | 240 | 3.60 | 6.0 (2.7) | Assy. Stock | RT2G046L00 | RDN42R10 | RR2046L00 |
| 46 5/8 (1185) | 38 5/8 (980) | 480 | 3.60 | 6.0 (2.7) | Assy. Stock | RT2P046L00 | RDN42R11 | RR2046L00 |
| 61 5/8 (1560) | 53 1/4 (1350) | 240 | 5.00 | 7.7 (3.5) | Assy. Stock | RT2G061G00 | RDN57J10 | RR2061G00 |
| 61 5/8 (1560) | 53 1/4 (1350) | 480 | 5.00 | 7.7 (3.5) | Assy. Stock | RT2P061G00 | RDN57J11 | RR2061G00 |
| 73 3/4 (1875) | 65 5/8 (1650) | 240 | 6.00 | 9.1 (4.1) | Assy. Stock | RT2G073N00 | RDN69E10 | RR2073N00 |
| 73 3/4 (1875) | 65 5/8 (1650) | 480 | 6.00 | 9.1 (4.1) | Assy. Stock | RT2P073N00 | RDN69E11 | RR2073N00 |
| 85 5/8 (2180) | 77 5/8 (1955) | 240 | 7.20 | 10.5 (4.8) | Assy. Stock | RT2G085N00 | RDN81E10 | RR2085N00 |
| 85 5/8 (2180) | 77 5/8 (1955) | 480 | 7.20 | 10.5 (4.8) | Assy. Stock | RT2P085N00 | RDN81E11 | RR2085N00 |

Hairpin Element



| | | | | | | | | |
|---------------|---------------|-----|------|------------|-------------|------------|--------------|-----------|
| 12 3/4 (325) | 8 3/8 (210) | 120 | 0.80 | 2.1 (0.95) | Assy. Stock | RU1A012N00 | RDN21B1UAAB | RR3012N00 |
| 12 3/4 (325) | 8 3/8 (210) | 240 | 0.80 | 2.1 (0.95) | Assy. Stock | RU1G012N00 | RDN21B10UAAA | RR3012N00 |
| 15 3/8 (405) | 11 7/16 (290) | 120 | 1.10 | 2.4 (1.1) | Assy. Stock | RU1A015R00 | RDN27C1UAAA | RR3015R00 |
| 15 3/8 (405) | 11 7/16 (290) | 240 | 1.10 | 2.4 (1.1) | Assy. Stock | RU1G015R00 | RDN27C10UAAC | RR3015R00 |
| 23 3/4 (605) | 19 3/16 (490) | 240 | 1.80 | 3.3 (1.5) | Assy. Stock | RU1G023N00 | RDN42R10UAAC | RR3023N00 |
| 23 3/4 (605) | 19 3/16 (490) | 480 | 1.80 | 3.3 (1.5) | Assy. Stock | RU1P023N00 | RDN42R11UAAB | RR3023N00 |
| 31 1/4 (795) | 26 3/16 (675) | 240 | 2.50 | 4.2 (1.9) | Assy. Stock | RU1G031E00 | RDN57J10UAAB | RR3031E00 |
| 31 1/4 (795) | 26 3/16 (675) | 480 | 2.50 | 4.2 (1.9) | Assy. Stock | RU1P031E00 | RDN57J11UAAB | RR3031E00 |
| 37 1/4 (945) | 32 7/16 (825) | 240 | 3.00 | 4.9 (2.2) | Assy. Stock | RU1G037E00 | RDN69E10UAAB | RR3037E00 |
| 37 1/4 (945) | 32 7/16 (825) | 480 | 3.00 | 4.9 (2.2) | Assy. Stock | RU1P037E00 | RDN69E11UAAB | RR3037E00 |
| 43 3/8 (1150) | 38 7/16 (975) | 240 | 3.60 | 5.6 (2.5) | Assy. Stock | RU1G043G00 | RDN81E10UAAB | RR3043G00 |
| 43 3/8 (1150) | 38 7/16 (975) | 480 | 3.60 | 5.6 (2.5) | Assy. Stock | RU1P043G00 | RDN81E11UAAB | RR3043G00 |

Radiant Heaters

F.O.B.: St. Louis, Missouri

RAYMAX 1525

Hairpin Element
with Liquid Tight Housing



| Overall Length | | Heated Length | | Volts | kW | Approx Net Wt. | | Availability | Code No. | Replacement Element Code No. | Replacement Reflector Code No. |
|----------------|--------|---------------|-------|-------|------|----------------|-------|--------------|------------|------------------------------|--------------------------------|
| in | (mm) | in | (mm) | | | lbs | (kg) | | | | |
| 12 3/4 | (325) | 8 3/8 | (210) | 120 | 0.80 | 2.5 | (1.1) | Assy. Stock | RS1A012N00 | RDN21B1BAAB | RR4012N00 |
| 12 3/4 | (325) | 8 3/8 | (210) | 240 | 0.80 | 2.5 | (1.1) | Assy. Stock | RS1G012N00 | RDN21B10BAAA | RR4012N00 |
| 15 1/8 | (405) | 11 1/8 | (290) | 120 | 1.10 | 2.9 | (1.3) | Assy. Stock | RS1A015R00 | RDN27C1BAAB | RR4015R00 |
| 15 1/8 | (405) | 11 1/8 | (290) | 240 | 1.10 | 2.9 | (1.3) | Assy. Stock | RS1G015R00 | RDN27C10BAAA | RR4015R00 |
| 23 3/4 | (605) | 19 3/8 | (490) | 240 | 1.80 | 3.8 | (1.7) | Assy. Stock | RS1G023N00 | RDN42R10BAAD | RR4023N00 |
| 23 3/4 | (605) | 19 3/8 | (490) | 480 | 1.80 | 3.8 | (1.7) | Assy. Stock | RS1P023N00 | RDN42R11BAAD | RR4023N00 |
| 31 1/4 | (795) | 26 3/8 | (675) | 240 | 2.50 | 4.8 | (2.2) | Assy. Stock | RS1G031E00 | RDN57J10BAAB | RR4031E00 |
| 31 1/4 | (795) | 26 3/8 | (675) | 480 | 2.50 | 4.8 | (2.2) | Assy. Stock | RS1P031E00 | RDN57J11BAAA | RR4031E00 |
| 37 1/4 | (945) | 32 3/8 | (825) | 240 | 3.00 | 5.5 | (2.5) | Assy. Stock | RS1G037E00 | RDN69E10BAAD | RR4037E00 |
| 37 1/4 | (945) | 32 3/8 | (825) | 480 | 3.00 | 5.5 | (2.5) | Assy. Stock | RS1P037E00 | RDN69E11BAAD | RR4037E00 |
| 43 3/8 | (1150) | 38 3/8 | (975) | 240 | 3.60 | 6.2 | (2.8) | Assy. Stock | RS1G043G00 | RDN81E10BAAB | RR4043G00 |
| 43 3/8 | (1150) | 38 3/8 | (975) | 480 | 3.60 | 6.2 | (2.8) | Assy. Stock | RS1P043G00 | RDN81E11BAAA | RR4043G00 |

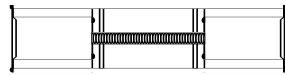

Note: Quartz tube elements must be operated in a horizontal position.

Quartz Tube Element

| | | | | | | | | | | | |
|--------|--------|----|--------|-----|------|-----|-------|-------------|------------|---------------|-----------|
| 18 1/8 | (460) | 10 | (255) | 120 | 0.50 | 2.4 | (1.1) | Assy. Stock | RG1A018B00 | RQB12FA05001B | RR5018B00 |
| 26 1/8 | (660) | 18 | (455) | 120 | 0.90 | 3.2 | (1.4) | Assy. Stock | RG1A026B00 | RQB20EA09001B | RR5026B00 |
| 26 1/8 | (660) | 18 | (455) | 240 | 0.90 | 3.2 | (1.4) | Assy. Stock | RG1G026B00 | RQB20EG09001B | RR5026B00 |
| 33 1/8 | (840) | 25 | (635) | 120 | 1.25 | 3.9 | (1.7) | Assy. Stock | RG1A033B00 | RQB27GA12001B | RR5033B00 |
| 33 1/8 | (840) | 25 | (635) | 240 | 1.25 | 3.9 | (1.7) | Assy. Stock | RG1G033B00 | RQB27GG12001B | RR5033B00 |
| 45 3/8 | (1165) | 38 | (965) | 240 | 1.90 | 5.1 | (2.3) | Assy. Stock | RG1G045S00 | RQB40DG19001B | RR5045S00 |
| 45 3/8 | (1165) | 38 | (965) | 480 | 1.90 | 5.1 | (2.3) | Assy. Stock | RG1P045S00 | RQB40DP19001B | RR5045S00 |
| 60 3/8 | (1550) | 53 | (1345) | 240 | 2.65 | 6.6 | (3.0) | Assy. Stock | RG1G060S00 | RQB55HG26001B | RR5060S00 |
| 60 3/8 | (1550) | 53 | (1345) | 480 | 2.65 | 6.6 | (3.0) | Assy. Stock | RG1P060S00 | RQB55HP26001B | RR5060S00 |

Tubular Replacement Elements for Reflector Style Radiant Heaters

The following tubular radiant heating elements are available for replacing popular non-Watlow radiant elements.

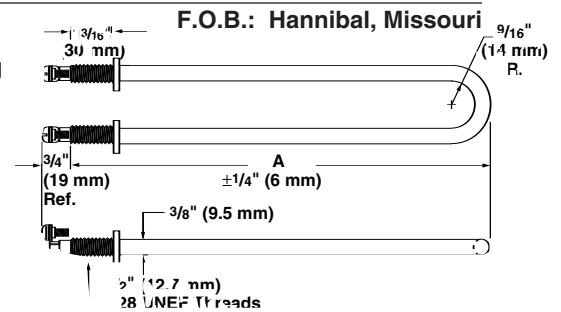

F.O.B.: Hannibal, Missouri

Hairpin (U-Shaped) Element With Liquid Tight Bulkheads Stock Chart

| Hairpin A Dimension | Volts | Watts | Approx. Net Wt. | | Availability | Chromalox® | | Watlow Code No. | |
|---------------------|--------|-------|-----------------|------|--------------|-------------|--------|-----------------|-----------|
| | | | in | (mm) | | oz | (g) | | PCN |
| 10 5/8 | (266) | 120 | 800 | 6 | (170) | Assy. Stock | 106673 | UTU-2LT | RDN21B1B |
| 10 5/8 | (266) | 240 | 800 | 6 | (170) | Assy. Stock | 106681 | UTU-2LT | RDN21B10B |
| 13 5/8 | (344) | 120 | 1100 | 8 | (225) | Assy. Stock | 106690 | UTU-3LT | RDN27C1B |
| 13 5/8 | (344) | 240 | 1100 | 8 | (225) | Assy. Stock | 106702 | UTU-3LT | RDN27C10B |
| 21 5/8 | (541) | 240 | 1800 | 13 | (370) | Assy. Stock | 106710 | UTU-4LT | RDN42R10B |
| 21 5/8 | (541) | 480 | 1800 | 13 | (370) | Assy. Stock | 106729 | UTU-4LT | RDN42R11B |
| 28 1/2 | (728) | 240 | 2500 | 16 | (455) | Assy. Stock | 106737 | UTU-5LT | RDN57J10B |
| 28 1/2 | (728) | 480 | 2500 | 16 | (455) | Assy. Stock | 106745 | UTU-5LT | RDN57J11B |
| 34 3/8 | (878) | 240 | 3000 | 19 | (540) | Assy. Stock | 106753 | UTU-6LT | RDN69E10B |
| 34 3/8 | (878) | 480 | 3000 | 19 | (540) | Assy. Stock | 106761 | UTU-6LT | RDN69E11B |
| 40 3/8 | (1030) | 240 | 3600 | 22 | (625) | Assy. Stock | 106770 | UTU-7LT | RDN81E10B |
| 40 3/8 | (1030) | 480 | 3600 | 22 | (625) | Assy. Stock | 106788 | UTU-7LT | RDN81E11B |

Radiant Heaters

F.O.B.: Hannibal, Missouri

RAYMAX 1525

Tubular Replacement Elements for Reflector Style Radiant Heaters

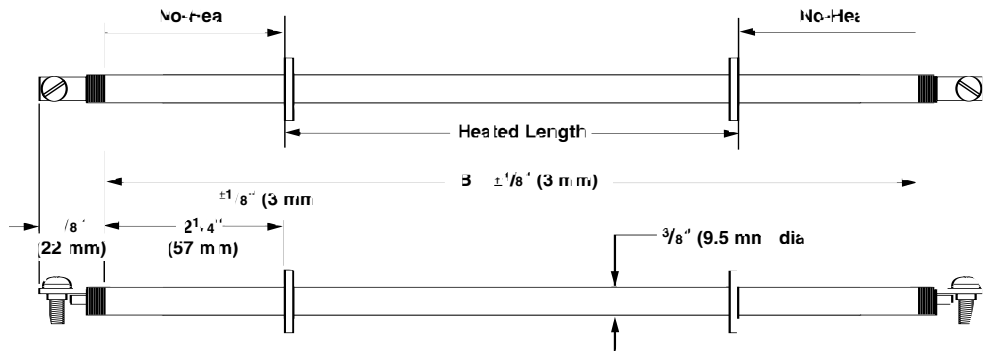

Straight Element Stock Chart

| Sheath B Dimension inch (mm) | Heated Length inch (mm) | No-Heat Length inch (mm) | Volts | Watts | Approx. Net wt. oz. (g) | Availability | Chromalox | | Watlow Code No. |
|------------------------------------|-------------------------------|--------------------------------|-------|-------|-------------------------------|--------------|-----------|--------------|--------------------|
| | | | | | | | PCN | Catalog No. | |
| 10 1/4 (260) | 7 1/4 (184) | 1 1/2 (38) | 120 | 400 | 3 (85) | Assy. Stock | 147766 | RTU-2063AX35 | RDN10E1 |
| 16 5/8 (422) | 13 5/8 (346) | 1 1/2 (38) | 120 | 650 | 5 (140) | Assy. Stock | 147774 | RTU-2063AX29 | RDN16L1 |
| 21 1/16 (535) | 16 13/16 (409) | 2 1/2 (54) | 120 | 800 | 6 (170) | Assy. Stock | 106112 | RTU-2083A | RDN21B1 |
| 21 1/16 (535) | 16 13/16 (409) | 2 1/2 (54) | 208 | 800 | 6 (170) | Standard | 106120 | RTU-2083AV | RDN21B2 |
| 21 1/16 (535) | 16 13/16 (409) | 2 1/2 (54) | 240 | 800 | 6 (170) | Assy. Stock | 106139 | RTU-2083A | RDN21B10 |
| 21 1/16 (535) | 16 13/16 (409) | 2 1/2 (54) | 277 | 800 | 6 (170) | Standard | 106147 | RTU-2083AV | RDN21B4 |
| 27 7/8 (688) | 22 7/8 (580) | 2 1/2 (54) | 120 | 1100 | 8 (225) | Assy. Stock | 106155 | RTU-3113A | RDN27C1 |
| 27 7/8 (688) | 22 7/8 (580) | 2 1/2 (54) | 208 | 1100 | 8 (225) | Standard | 106163 | RTU-3113AV | RDN27C2 |
| 27 7/8 (688) | 22 7/8 (580) | 2 1/2 (54) | 240 | 1100 | 8 (225) | Assy. Stock | 106171 | RTU-3113A | RDN27C10 |
| 27 7/8 (688) | 22 7/8 (580) | 2 1/2 (54) | 277 | 1100 | 8 (225) | Standard | 106180 | RTU-3113AV | RDN27C4 |
| 32 1/8 (816) | 27 7/8 (580) | 2 1/2 (54) | 240 | 1300 | 9 (255) | Assy. Stock | 108409 | RTU-3133A | RDN32C10 |
| 32 1/8 (816) | 27 7/8 (580) | 2 1/2 (54) | 480 | 1300 | 9 (255) | Assy. Stock | 108396 | RTU-3133A | RDN32C11 |
| 42 7/8 (1090) | 38 5/8 (905) | 2 1/2 (54) | 208 | 1800 | 13 (370) | Standard | 106198 | RTU-4183AV | RDN42R2 |
| 42 7/8 (1090) | 38 5/8 (905) | 2 1/2 (54) | 240 | 1800 | 13 (370) | Assy. Stock | 106200 | RTU-4183A | RDN42R10 |
| 42 7/8 (1090) | 38 5/8 (905) | 2 1/2 (54) | 277 | 1800 | 13 (370) | Standard | 106219 | RTU-3133AV | RDN42R4 |
| 42 7/8 (1090) | 38 5/8 (905) | 2 1/2 (54) | 480 | 1800 | 13 (370) | Assy. Stock | 106227 | RTU-3133A | RDN42R11 |
| 57 1/2 (1460) | 53 1/4 (1350) | 2 1/2 (54) | 208 | 2500 | 16 (455) | Standard | 106235 | RTU-5253AV | RDN57J2 |
| 57 1/2 (1460) | 53 1/4 (1350) | 2 1/2 (54) | 240 | 2500 | 16 (455) | Assy. Stock | 106243 | RTU-5253A | RDN57J10 |
| 57 1/2 (1460) | 53 1/4 (1350) | 2 1/2 (54) | 277 | 2500 | 16 (455) | Standard | 106251 | RTU-5253AV | RDN57J4 |
| 57 1/2 (1460) | 53 1/4 (1350) | 2 1/2 (54) | 480 | 2500 | 16 (455) | Assy. Stock | 106260 | RTU-5253A | RDN57J11 |
| 69 1/4 (1760) | 65 (1650) | 2 1/2 (54) | 208 | 3000 | 19 (540) | Standard | 106278 | RTU-6303AV | RDN69E2 |
| 69 1/4 (1760) | 65 (1650) | 2 1/2 (54) | 240 | 3000 | 19 (540) | Assy. Stock | 106286 | RTU-6303A | RDN69E10 |
| 69 1/4 (1760) | 65 (1650) | 2 1/2 (54) | 277 | 3000 | 19 (540) | Standard | 106294 | RTU-6303AV | RDN69E4 |
| 69 1/4 (1760) | 65 (1650) | 2 1/2 (54) | 480 | 3000 | 19 (540) | Assy. Stock | 106307 | RTU-6303A | RDN69E11 |
| 81 1/4 (2065) | 77 (1955) | 2 1/2 (54) | 208 | 3600 | 22 (625) | Standard | 106315 | RTU-7363AV | RDN81E2 |
| 81 1/4 (2065) | 77 (1955) | 2 1/2 (54) | 240 | 3600 | 22 (625) | Assy. Stock | 106323 | RTU-7363A | RDN81E10 |
| 81 1/4 (2065) | 77 (1955) | 2 1/2 (54) | 277 | 3600 | 22 (625) | Standard | 106331 | RTU-7363AV | RDN81E4 |
| 81 1/4 (2065) | 77 (1955) | 2 1/2 (54) | 480 | 3600 | 22 (625) | Assy. Stock | 106340 | RTU-7363A | RDN81E11 |
| 109 1/4 (2775)Ⓢ | 105 (2665) | 2 1/2 (54) | 240 | 4000 | 32 (905) | Standard | 106358 | RTU-7303AX10 | RDN109E10 |
| 134 1/2 (3415)Ⓢ | 127 3/4 (3245) | 3 3/8 (85) | 240 | 5000 | 37 (1050) | Standard | 106366 | RTU-7303AX13 | RDN134J10 |
| 153 3/8 (3895)Ⓢ | 145 7/8 (3700) | 4 (101) | 240 | 5500 | 40 (1135) | Standard | 106374 | RTU-7303AX9A | RDN153R10 |
| 179 1/4 (4550)Ⓢ | 171 1/4 (4350) | 4 (101) | 240 | 6500 | 51 (1445) | Standard | 106382 | RTU-7363AX38 | RDN179E10 |

Radiant Heaters

F.O.B.: Hannibal, Missouri

RAYMAX 1525

Tubular Replacement Elements for Reflector Style Radiant Heaters

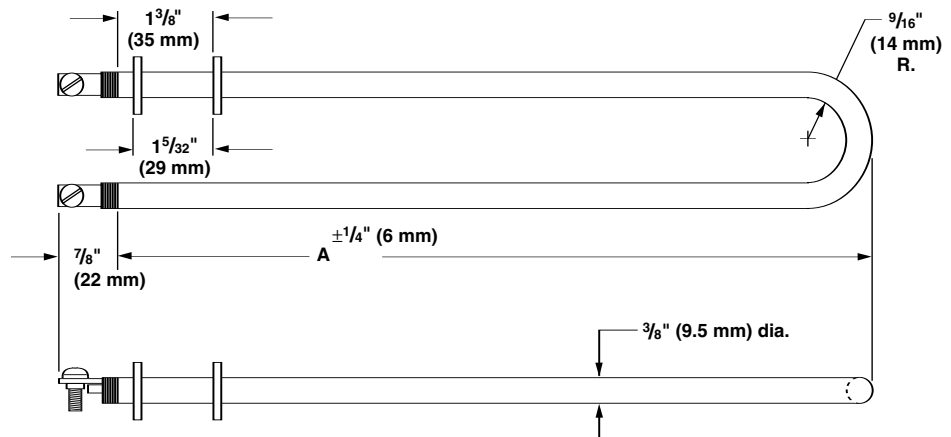

Hairpin (U-Shaped) Element Stock Chart

| Hairpin A Dimension in (mm) | Volts | Watts | Approx. Net Wt. oz (g) | Availability | Chromalox® | | Watlow Code No. |
|-----------------------------------|-------|-------|------------------------------|--------------|------------|-------------|--------------------|
| | | | | | PCN | Catalog No. | |
| 10 1/2 (266) | 120 | 800 | 6 (170) | Assy. Stock | 106438 | UTU-2 | RDN21B1U |
| 10 1/2 (266) | 240 | 800 | 6 (170) | Assy. Stock | 106454 | UTU-2 | RDN21B10U |
| 10 1/2 (266) | 277 | 800 | 6 (170) | Standard | 106462 | UTU-2V | RDN21B4U |
| 13 5/16 (344) | 120 | 1100 | 8 (225) | Assy. Stock | 106470 | UTU-3 | RDN27C1U |
| 13 5/16 (344) | 240 | 1100 | 8 (225) | Assy. Stock | 106497 | UTU-3 | RDN27C10U |
| 13 5/16 (344) | 277 | 1100 | 8 (225) | Standard | 106500 | UTU-3V | RDN27C4U |
| 21 5/16 (541) | 208 | 1800 | 13 (370) | Standard | 106518 | UTU-4V | RDN42R2U |
| 21 5/16 (541) | 240 | 1800 | 13 (370) | Assy. Stock | 106526 | UTU-4 | RDN42R10U |
| 21 5/16 (541) | 480 | 1800 | 13 (370) | Assy. Stock | 106542 | UTU-4 | RDN42R11U |
| 28 11/16 (728) | 208 | 2500 | 16 (455) | Standard | 106550 | UTU-5V | RDN57J2U |
| 28 11/16 (728) | 240 | 2500 | 16 (455) | Assy. Stock | 106569 | UTU-5 | RDN57J10U |
| 28 11/16 (728) | 277 | 2500 | 16 (455) | Standard | 106577 | UTU-5V | RDN57J4U |
| 28 11/16 (728) | 480 | 2500 | 16 (455) | Assy. Stock | 106585 | UTU-5 | RDN57J11U |
| 34 3/16 (878) | 240 | 3000 | 19 (540) | Assy. Stock | 106606 | UTU-6 | RDN69E10U |
| 34 3/16 (878) | 480 | 3000 | 19 (540) | Assy. Stock | 106622 | UTU-6 | RDN69E11U |
| 40 3/16 (1030) | 240 | 3600 | 22 (625) | Assy. Stock | 106649 | UTU-7 | RDN81E10U |
| 40 3/16 (1030) | 277 | 3600 | 22 (625) | Standard | 106657 | UTU-7V | RDN81E4U |
| 40 3/16 (1030) | 480 | 3600 | 22 (625) | Assy. Stock | 106665 | UTU-7 | RDN81E11U |

Chromalox® is a registered trademark of Emerson Electric Co.

How to Order

For units listed in the stock charts, please specify:

- Watlow code number
- Volts/watts
- Style (straight length, hairpin or hairpin with bulkheads)
- Quantity

If our stock elements do not meet your needs, Watlow can provide a **made-to-order** unit.

Details on constructions, materials and options are contained in **Tubular and Process Assemblies**—WATROD Heating Elements, pages 273 to 295. For **made-to-order** units, please specify:

- Volts/watts
- Sheath material and diameter
- Sheath length and no-heat length
- Terminations or terminal pin length
- Bend configuration, if applicable
- Mounting method
- Quantity

Availability

Assembly Stock: Three to five days

Standard: 10 working days

Modified Stock ①: Five to seven working days

Made-to-Order: Four to six weeks

① Assembly Stock with catalog options.